

## OFFICE SUPPLIES ACTA

Designed by **Pascual Salvador**



### DESCRIPTION

A range of desktop and foot signs, to install as fixed or occasional items as required.



### ACTA-10 MERCHANDISING

A range of desktop and foot signs, to install as fixed or occasional items as required.

Tabletop leaflet holder (for leaflets 210x100 mm) for indoor use. Transparent methacrylate holder that affords a view of the leaflets inside. Base with extruded aluminum trim. There are additional models available in the same series in various sizes, signage variations and merchandising formats.

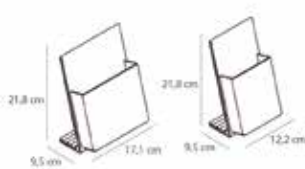

#### MEASUREMENTS

W 12,2cm × L 9,5cm × H 21,8cm

W 4.81in × L 3.75in × H 8.59in

#### CHARACTERISTICS

**Weight** 0,9 Kg.

STD units	Packaging dim. (cm)	Units Container 20'	Units Container 40'	Units Container HC	Units Traylor 70m <sup>2</sup>	Units Truck 100m <sup>2</sup>
1X	× ×		9504			11880

#### SHELL COLOR

○  
Transparent

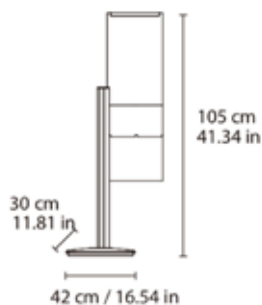

## ACTA-100 MERCHANDISING

A range of desktop and foot signs, to install as fixed or occasional items as required.

Indoor-free standing support DIN A4. Comprised of a transparent methacrylate poster holder. Frame made of extruded aluminum profile supported on a cast steel base, with cover trim, to provide structural stability. In terms of functionality and ergonomics, allows effortless literature replacement, with the holder opening by sliding the paper towards one end. There are additional models available in the same series in various sizes, signage variations and merchandising formats.

### MEASUREMENTS

W 42cm × L 30cm × H 105cm

W 16.54in × L 11.82in × H 41.34in

### CHARACTERISTICS

**Weight** 13 Kg.

STD units	Packaging dim. (cm)	Units Container 20'	Units Container 40'	Units Container HC	Units Trayler 70m <sup>3</sup>	Units Truck 100m <sup>3</sup>
1X	x x		317			396

### SHELL COLOR



Silver

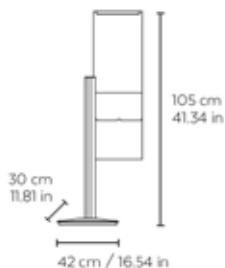

## ACTA-101/1 MERCHANDISING

A range of desktop and foot signs, to install as fixed or occasional items as required.

Indoor free standing support DIN A4 metal. Comprised of a transparent methacrylate holder for holding signage. Frame made of extruded aluminum profile supported on a cast steel base, with cover trim, to provide structural stability. In terms of functionality and ergonomics, allows effortless DIN A4 replacement, with the holder opening by sliding the paper towards one end. There are additional models available in the same series in various sizes, signage variations and merchandising formats.

### MEASUREMENTS

W 42cm × L 30cm × H 105cm

W 16.54in × L 11.82in × H 41.34in

### CHARACTERISTICS

**Weight** 13 Kg.

STD units	Packaging dim. (cm)	Units Container 20'	Units Container 40'	Units Container HC	Units Trayler 70m <sup>3</sup>	Units Truck 100m <sup>3</sup>
1X	x x		146			182

### SHELL COLOR



Silver Grey

## ACTA-11 MERCHANDISING

A range of desktop and foot signs, to install as fixed or occasional items as required.

Tabletop leaflet holder (for leaflets DIN A-5 vertical) for indoor use. Transparent methacrylate holder that affords a view of the leaflets inside. Base with extruded aluminum trim. There are additional models available in the same series in various sizes, signage variations and merchandising formats.

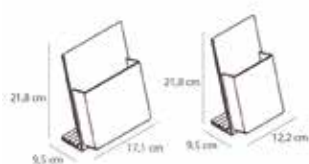

### MEASUREMENTS

W 17,1cm × L 9,5cm × H 21,8cm  
W 6.74in × L 3.75in × H 8.59in

### CHARACTERISTICS

**Weight** 0,9 Kg.

STD units	Packaging dim. (cm)	Units Container 20'	Units Container 40'	Units Container HC	Units Trayler 70m <sup>3</sup>	Units Truck 100m <sup>3</sup>
1X	x x		9504			11880

### SHELL COLOR



Silver Grey

## ACTA-110/1 MERCHANDISING

A range of desktop and foot signs, to install as fixed or occasional items as required.

One side indoor free-standing display stand for 100x70 posters. Frame made of extruded aluminum profiles with a polycarbonate protector supported on a cast steel base with decorative trim to provide structural stability. In terms of functionality and ergonomics, allows effortless and toolless poster replacement by means of a simple lateral opening in the frame profile. There are additional models available in the same series in various sizes, signage variations and merchandising formats. ACCESSORIES: leaflets holder ref. Acta-200/1 with five holders for 210x100 mm leaflets, ref. Acta-202/1 with five holders for DIN A5 leaflets, ref. Acta-220/1 magazine rack and ref. Acta-250 set of wheels for two bases.

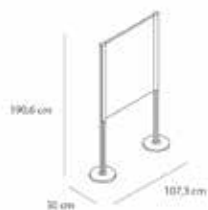

### MEASUREMENTS

W 107,3cm × L 30cm × H 190,6cm  
W 42.25in × L 11.82in × H 75.04in

### CHARACTERISTICS

**Weight** 28 Kg.

STD units	Packaging dim. (cm)	Units Container 20'	Units Container 40'	Units Container HC	Units Trayler 70m <sup>3</sup>	Units Truck 100m <sup>3</sup>
1X	x x		10692			13365

### SHELL COLOR



Silver Grey

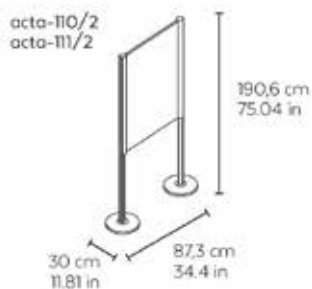

### ACTA-110/2 MERCHANDISING

A range of desktop and foot signs, to install as fixed or occasional items as required. One side indoor free-standing display stand for 70x50 posters. Frame made of extruded aluminum profiles with a polycarbonate protector supported on a cast steel base with decorative trim to provide structural stability. In terms of functionality and ergonomics, allows effortless and toolless poster replacement by means of a simple lateral opening in the frame profile. There are additional models available in the same series in various sizes, signage variations and merchandising formats. ACCESSORIES: leaflet holder ref. Acta-200/2 with four holders for 210x100 mm leaflets, and ref. Acta-250 set of wheels for two bases.

#### MEASUREMENTS

W 87,3cm × L 30cm × H 190,6cm

W 34.38in × L 11.82in × H 75.04in

#### CHARACTERISTICS

**Weight** 27 Kg.

STD units	Packaging dim. (cm)	Units Container 20'	Units Container 40'	Units Container HC	Units Trayler 70m <sup>3</sup>	Units Truck 100m <sup>3</sup>
1X	x x		10692			13365

#### SHELL COLOR



Silver Grey

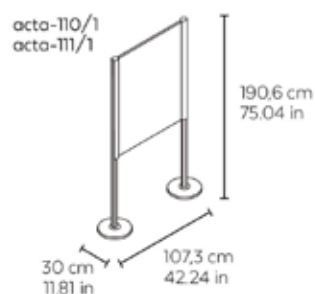

### ACTA-111/1 MERCHANDISING

A range of desktop and foot signs, to install as fixed or occasional items as required. Premiodeltadeoro Two-sided indoor free-standing display stand for 100x70 posters. Frame made of extruded aluminum profiles with a polycarbonate protector supported on a cast steel base with decorative trim to provide structural stability. In terms of functionality and ergonomics, allows effortless and toolless poster replacement by means of a simple lateral opening in the frame profile. There are additional models available in the same series in various sizes, signage variations and merchandising formats. ACCESSORIES: set of wheels for two bases ref. Acta-250

#### MEASUREMENTS

W 107,3cm × L 30cm × H 190,6cm

W 42.25in × L 11.82in × H 75.04in

#### CHARACTERISTICS

**Weight** 28 Kg.

STD units	Packaging dim. (cm)	Units Container 20'	Units Container 40'	Units Container HC	Units Trayler 70m <sup>3</sup>	Units Truck 100m <sup>3</sup>
1X	x x		10692			13365

#### SHELL COLOR



Silver Grey

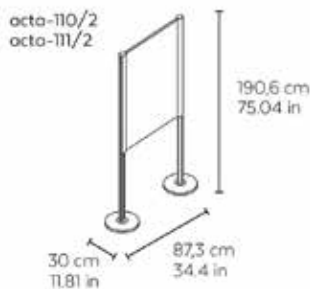

### ACTA-111/2 MERCHANDISING

A range of desktop and foot signs, to install as fixed or occasional items as required. Two-sided indoor free-standing display stand for 70x50 posters. Frame made of extruded aluminum profiles with a polycarbonate protector supported on a cast steel base with decorative trim to provide structural stability. In terms of functionality and ergonomics, allows effortless and toolless posters replacement by means of a simple lateral opening in the frame profile. There are additional models available in the same series in various sizes, signage variations and merchandising formats. ACCESSORIES: set of wheels for two bases ref. Acta-250

#### MEASUREMENTS

W 87,3cm × L 30cm × H 190,6cm  
W 34.38in × L 11.82in × H 75.04in

#### CHARACTERISTICS

**Weight** 28 Kg.

STD units	Packaging dim. (cm)	Units Container 20'	Units Container 40'	Units Container HC	Units Trayler 70m <sup>3</sup>	Units Truck 100m <sup>3</sup>
1X	x x		10692			13365

#### SHELL COLOR



Silver Grey

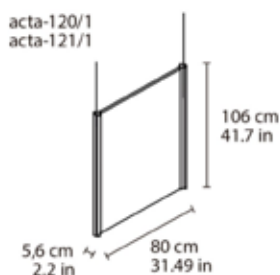

### ACTA-120/1 MERCHANDISING

Indoor one-sided hanging poster holder for 100x70 cm poster. Frame made of extruded aluminum profiles with a polycarbonate protector. Easy ceiling installation using leaded cable allowing for adjustment to the desired height. In terms of functionality and ergonomics, allows effortless and toolless poster replacement by means of a simple lateral opening in the frame profile. There are additional models available in the same series in various sizes, signage variations and merchandising formats.

#### MEASUREMENTS

W 80cm × L 5,6cm × H 106cm  
W 31.5in × L 2.2in × H 41.74in

#### CHARACTERISTICS

**Weight** 7,5 Kg.

STD units	Packaging dim. (cm)	Units Container 20'	Units Container 40'	Units Container HC	Units Trayler 70m <sup>3</sup>	Units Truck 100m <sup>3</sup>
1X	x x		634			792

#### SHELL COLOR



Silver Grey

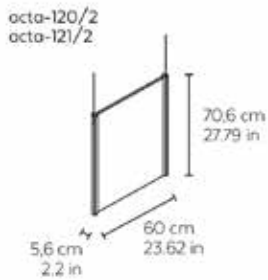

## ACTA-120/2 MERCHANDISING

Indoor one-sided hanging poster holder for 70x50 cm poster. Frame made of extruded aluminum profiles with a polycarbonate holder. Easy ceiling installation using leaded cable allowing for adjustment to the desired height. In terms of functionality and ergonomics, allows effortless and toolless poster replacement by means of a simple lateral opening in the frame profile. There are additional models available in the same series in various sizes, signage variations and merchandising formats.

### MEASUREMENTS

W 60cm × L 5,6cm × H 70,6cm  
W 23.63in × L 2.2in × H 27.8in

### CHARACTERISTICS

**Weight** 5,5 Kg.

STD units	Packaging dim. (cm)	Units Container 20'	Units Container 40'	Units Container HC	Units Trayler 70m <sup>3</sup>	Units Truck 100m <sup>3</sup>
1X	x x		634			792

### SHELL COLOR



Silver Grey



## ACTA-121/1 MERCHANDISING

A range of desktop and foot signs, to install as fixed or occasional items as required. Indoor two-sided hanging poster display for 100x70 cm posters. Frame made of extruded aluminum profiles with a polycarbonate protector. Easy ceiling installation using leaded cable allowing for adjustment to the desired height. In terms of functionality and ergonomics, allows effortless and toolless poster replacement by means of a simple lateral opening in the frame profile. There are additional models available in the same series in various sizes, signage variations and merchandising formats.

### MEASUREMENTS

W 80cm × L 5,6cm × H 106cm  
W 31.5in × L 2.2in × H 41.74in

### CHARACTERISTICS

**Weight** 7,5 Kg.

STD units	Packaging dim. (cm)	Units Container 20'	Units Container 40'	Units Container HC	Units Trayler 70m <sup>3</sup>	Units Truck 100m <sup>3</sup>
1X	x x		422			528

### SHELL COLOR



Silver Grey

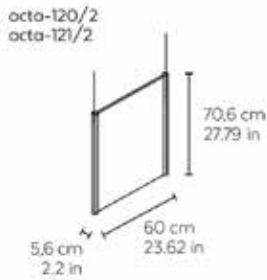

## ACTA-121/2 MERCHANDISING

A range of desktop and foot signs, to install as fixed or occasional items as required. Indoor two-sided hanging poster display for 70x50 cm posters. Frame made of extruded aluminum profiles with a polycarbonate holder. Easy ceiling installation using leaded cable allowing for adjustment to the desired height. In terms of functionality and ergonomics, allows effortless and toolless poster replacement by means of a simple lateral opening in the frame profile. There are additional models available in the same series in various sizes, signage variations and merchandising formats.

### MEASUREMENTS

W 60cm × L 5,6cm × H 70,6cm

W 23.63in × L 2.21in × H 27.8in

### CHARACTERISTICS

**Weight** 7,5 Kg.

STD units	Packaging dim. (cm)	Units Container 20'	Units Container 40'	Units Container HC	Units Trayler 70m <sup>3</sup>	Units Truck 100m <sup>3</sup>
1X	x x		422			528

### SHELL COLOR



Silver Grey

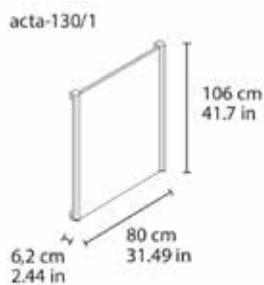

## ACTA-130/1 MERCHANDISING

A range of desktop and foot signs, to install as fixed or occasional items as required. Indoor wall-mounted poster display for 100x70 cm posters. Frame made of extruded aluminum profiles with a polycarbonate holder. Wall mount using screws and anchors (included). In terms of functionality and ergonomics, allows effortless and toolless poster replacement by means of a simple lateral opening in the frame profile.

### MEASUREMENTS

W 80cm × L 6,2cm × H 106cm

W 31.5in × L 2.45in × H 41.74in

### CHARACTERISTICS

**Weight** 7,5 Kg.

STD units	Packaging dim. (cm)	Units Container 20'	Units Container 40'	Units Container HC	Units Trayler 70m <sup>3</sup>	Units Truck 100m <sup>3</sup>
1X	x x		10692			13365

### SHELL COLOR



Silver Grey

acta-130/2

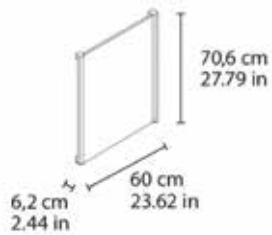

## ACTA-130/2 MERCHANDISING

A range of desktop and foot signs, to install as fixed or occasional items as required. Indoor wall-mounted poster display for 70x50 cm posters. Frame made of extruded aluminum profiles with a polycarbonate holder. Wall mount using screws and anchors (included). In terms of functionality and ergonomics, allows effortless and toolless literature replacement by means of a simple lateral opening in the frame profile. There are additional models available in the same series in various sizes, signage variations and merchandising formats.

### MEASUREMENTS

W 60cm × L 6,2cm × H 70,6cm

W 23.63in × L 2.45in × H 27.8in

### CHARACTERISTICS

**Weight** 5,5 Kg.

STD units	Packaging dim. (cm)	Units Container 20'	Units Container 40'	Units Container HC	Units Trayler 70m <sup>3</sup>	Units Truck 100m <sup>3</sup>
1X	x x		211			264

### SHELL COLOR



Silver Grey

## ACTA-20 MERCHANDISING

A range of desktop and foot signs, to install as fixed or occasional items as required.

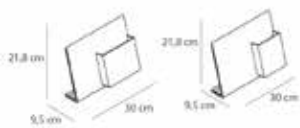

Tabletop leaflet holder (for leaflets 210x100 mm) with Din A4 holder for indoor use. Tabletop leaflet holder and Din A4 holder in transparent methacrylate that affords a view of the leaflets inside. Base with extruded aluminum trim. There are additional models available in the same series in various sizes, signage variations and merchandising formats.

### MEASUREMENTS

W 30cm × L 9,5cm × H 21,8cm

W 11.82in × L 3.75in × H 8.59in

### CHARACTERISTICS

**Weight** 0,9 Kg.

STD units	Packaging dim. (cm)	Units Container 20'	Units Container 40'	Units Container HC	Units Trayler 70m <sup>3</sup>	Units Truck 100m <sup>3</sup>
1X	x x		9504			11880

### SHELL COLOR



Silver Grey



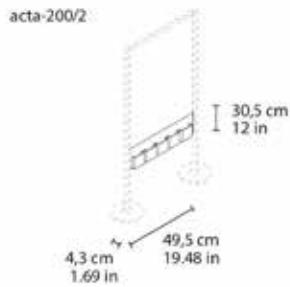

## ACTA-200/1 MERCHANDISING

A range of desktop and foot signs, to install as fixed or occasional items as required. Leaflets display accessory for Acta110/1. Comprised of an extruded aluminum frame with five transparent methacrylate holders for 210x100 mm leaflets.

### MEASUREMENTS

W 69,5cm × L 4,3cm × H 30,5cm  
W 27.37in × L 1.7in × H 12.01in

### CHARACTERISTICS

**Weight** 2,5 Kg.

STD units	Packaging dim. (cm)	Units Container 20'	Units Container 40'	Units Container HC	Units Trayler 70m <sup>3</sup>	Units Truck 100m <sup>3</sup>
1X	x x		96000			120000

### SHELL COLOR



Stainless



## ACTA-200/2 MERCHANDISING

A range of desktop and foot signs, to install as fixed or occasional items as required. Leaflets display accessory for Acta110/2. Comprised of an extruded aluminum frame with four transparent methacrylate holders for 210x100 mm leaflets.

### MEASUREMENTS

W 49,5cm × L 4,3cm × H 30,5cm  
W 19.49in × L 1.7in × H 12.01in

### CHARACTERISTICS

**Weight** 2,5 Kg.

STD units	Packaging dim. (cm)	Units Container 20'	Units Container 40'	Units Container HC	Units Trayler 70m <sup>3</sup>	Units Truck 100m <sup>3</sup>
1X	x x		96000			120000

### SHELL COLOR



Stainless

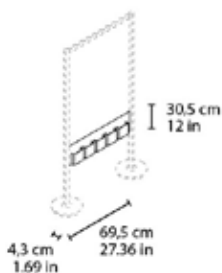

## ACTA-202/1 MERCHANDISING

A range of desktop and foot signs, to install as fixed or occasional items as required. Leaflet holder accessory for Acta110/1. Comprised of an extruded aluminum frame with four transparent methacrylate holders for DIN A5 leaflets.

### MEASUREMENTS

W 69,5cm × L 4,3cm × H 30,5cm  
W 27.37in × L 1.7in × H 12.01in

### CHARACTERISTICS

**Weight** 2,5 Kg.

STD units	Packaging dim. (cm)	Units Container 20'	Units Container 40'	Units Container HC	Units Trayler 70m <sup>3</sup>	Units Truck 100m <sup>3</sup>
1X	x x		96000			120000

### SHELL COLOR



Grey

## ACTA-21 MERCHANDISING

A range of desktop and foot signs, to install as fixed or occasional items as required.

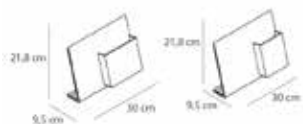

Tabletop leaflet holder (for leaflets Din A5 mm) with Din A4 holder for indoor use. Tabletop leaflet holder and Din A4 holder in transparent methacrylate that affords a view of the leaflets inside. Base with extruded aluminum trim. There are additional models available in the same series in various sizes, signage variations and merchandising formats.

### MEASUREMENTS

W 30cm × L 9,5cm × H 21,8cm

W 11.82in × L 3.75in × H 8.59in

### CHARACTERISTICS

**Weight** 0,9 Kg.

STD units	Packaging dim. (cm)	Units Container 20'	Units Container 40'	Units Container HC	Units Trayler 70m <sup>3</sup>	Units Truck 100m <sup>3</sup>
1X	x x		9504			11880

### SHELL COLOR



Grey

## ACTA 220/1

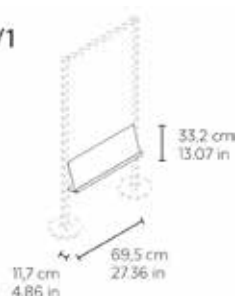

## ACTA-220/1 MERCHANDISING

A range of desktop and foot signs, to install as fixed or occasional items as required. Metal magazine holder accessory for Acta 110/1 and Acta 401.

### MEASUREMENTS

W 69,5cm × L 4,3cm × H 30,5cm

W 27.37in × L 1.7in × H 12.01in

### CHARACTERISTICS

**Weight** 2,5 Kg.

STD units	Packaging dim. (cm)	Units Container 20'	Units Container 40'	Units Container HC	Units Trayler 70m <sup>3</sup>	Units Truck 100m <sup>3</sup>
1X	x x		96000			120000

### SHELL COLOR



Grey

## ACTA-241 MERCHANDISING

A range of desktop and foot signs, to install as fixed or occasional items as required.



STD units	Packaging dim. (cm)	Units Container 20'	Units Container 40'	Units Container HC	Units Trayler 70m <sup>3</sup>	Units Truck 100m <sup>3</sup>
1X	x x		96000			120000

### SHELL COLOR



Black

## ACTA-300 MERCHANDISING

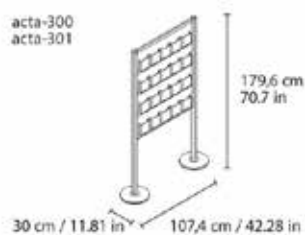

A range of desktop and foot signs, to install as fixed or occasional items as required.

Indoor standing leaflet display 1 sided for leaflets 210x100 mm. Frame made of extruded aluminum profiles with 20 methacrylate holders. Supported on two cast steel bases with trim to provide structural stability. Equipped with four rows of five holders each. There are additional models available in the same series in various sizes, types of signage and merchandising formats. ACCESSORIES: set of wheels for two bases ref. Acta-250

### MEASUREMENTS

W 107,4cm × L 30cm × H 179,6cm

W 42.29in × L 11.82in × H 70.7in

### CHARACTERISTICS

**Weight** 29,5 Kg.

STD units	Packaging dim. (cm)	Units Container 20'	Units Container 40'	Units Container HC	Units Trayler 70m <sup>3</sup>	Units Truck 100m <sup>3</sup>
1X	x x		211			264

### SHELL COLOR



Silver Grey

## ACTA-301 MERCHANDISING

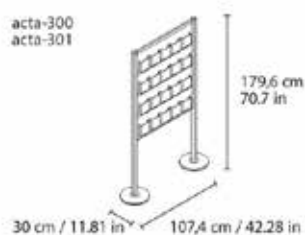

A range of desktop and foot signs, to install as fixed or occasional items as required.

Indoor standing leaflet display 2 sided for leaflets 210x100 mm. Frame made of extruded aluminum profiles supported on two cast steel bases with trim to provide structural stability. Equipped with four rows of five holders made of transparent methacrylate on both sides (total of 40). Also available in a two-sided format, model ref. Acta-301, additional models available in the same series in various types of signage and merchandising formats. ACCESSORIES: set of wheels for two bases ref. Acta-250

### MEASUREMENTS

W 107,4cm × L 30cm × H 179,6cm

W 42.29in × L 11.82in × H 70.7in

### CHARACTERISTICS

**Weight** 29,5 Kg.

STD units	Packaging dim. (cm)	Units Container 20'	Units Container 40'	Units Container HC	Units Trayler 70m <sup>3</sup>	Units Truck 100m <sup>3</sup>
1X	x x		211			264

### SHELL COLOR



Silver Grey

acta-305  
acta-306

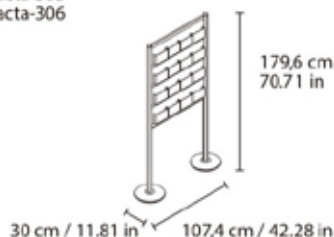

## ACTA-305 MERCHANDISING

A range of desktop and foot signs, to install as fixed or occasional items as required.

Indoor standing leaflet display 1 sided for leaflets Din A5. Frame made of extruded aluminum profiles with 16 methacrylate holders. Supported on two cast steel bases with trim to provide structural stability. Equipped with four rows of four holders each. Also available in a two-sided format, model ref. Acta-306, additional models available in the same series in various types of signage and merchandising formats. ACCESSORIES: set of wheels for two bases ref. Acta-250

### MEASUREMENTS

W 107,4cm × L 30cm × H 179,6cm

W 42.29in × L 11.82in × H 70.71in

### CHARACTERISTICS

**Weight** 28,5 Kg.

STD units	Packaging dim. (cm)	Units Container 20'	Units Container 40'	Units Container HC	Units Trayler 70m <sup>3</sup>	Units Truck 100m <sup>3</sup>
1X	x x		211			264

### SHELL COLOR



Silver Grey

acta-305  
acta-306

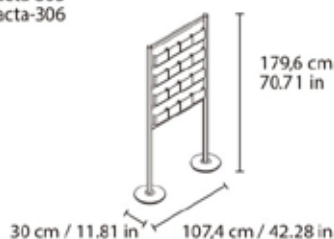

## ACTA-306 MERCHANDISING

A range of desktop and foot signs, to install as fixed or occasional items as required.

Indoor standing leaflet display 2 sided for leaflets Din A5. Frame made of extruded aluminum profiles supported on two cast steel bases with trim to provide structural stability. Equipped with four rows of four holders made of transparent methacrylate on both sides (total of 32). Also available in one-sided format, model ref. Acta-305, additional models available in the same series in various types of signage and merchandising formats. ACCESSORIES: set of wheels for two bases ref. Acta-250

### MEASUREMENTS

W 107,4cm × L 30cm × H 179,6cm

W 42.29in × L 11.82in × H 70.71in

### CHARACTERISTICS

**Weight** 28,5 Kg.

STD units	Packaging dim. (cm)	Units Container 20'	Units Container 40'	Units Container HC	Units Trayler 70m <sup>3</sup>	Units Truck 100m <sup>3</sup>
1X	x x		211			264

### SHELL COLOR



Silver Grey

## ACTA-310 MERCHANDISING

A range of desktop and foot signs, to install as fixed or occasional items as required.

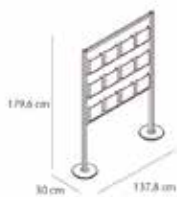

Indoor standing leaflet display 1 sided for leaflets Din A4 vertical. Frame made of extruded aluminum profiles with 12 methacrylate holders. Supported on two cast steel bases with trim to provide structural stability. Equipped with three rows of four holders each. Also available in a two-sided format, model ref. Acta-311, additional models available in the same series in various types of signage and merchandising formats. ACCESSORIES: set of wheels for two bases ref. Acta-250

### MEASUREMENTS

W 137,8cm × L 30cm × H 179,6cm

W 54.26in × L 11.82in × H 70.71in

### CHARACTERISTICS

**Weight** 28,5 Kg.

STD units	Packaging dim. (cm)	Units Container 20'	Units Container 40'	Units Container HC	Units Trayler 70m <sup>3</sup>	Units Truck 100m <sup>3</sup>
1X	x x		211			264

### SHELL COLOR



Silver Grey

## ACTA-311 MERCHANDISING

A range of desktop and foot signs, to install as fixed or occasional items as required.

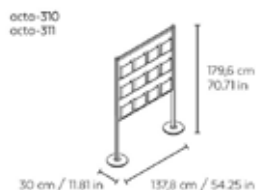

Indoor standing leaflet display 2 sided for leaflets Din A4. Frame made of extruded aluminum profiles supported on two cast steel bases with trim to provide structural stability. Equipped with three rows of four holders (total of 24) made of transparent methacrylate on both sides. Also available in a single-sided format, model ref. Acta-310, additional models available in the same series in various types of signage and merchandising formats. ACCESSORIES: set of wheels for two bases ref. Acta-250

### MEASUREMENTS

W 137,8cm × L 30cm × H 179,6cm

W 54.26in × L 11.82in × H 70.71in

### CHARACTERISTICS

**Weight** 28,5 Kg.

STD units	Packaging dim. (cm)	Units Container 20'	Units Container 40'	Units Container HC	Units Trayler 70m <sup>3</sup>	Units Truck 100m <sup>3</sup>
1X	x x		211			264

### SHELL COLOR



Silver Grey

### ACCESSORIES

Set of 2 wheels for two bases



### ACTA-330 MERCHANDISING

A range of desktop and foot signs, to install as fixed or occasional items as required. Indoor single-sided magazine rack for three Din A4 per shelf. Frame made of extruded aluminum profiles supported on two cast steel bases with trim to provide structural stability. There are additional models available in the same series in various sizes, types of signage and merchandising formats. ACCESSORIES: set of wheels for two bases ref. Acta-250

#### MEASUREMENTS

W 107cm × L 30cm × H 179,6cm

W 42.13in × L 11.82in × H 70.7in

STD units	Packaging dim. (cm)	Units Container 20'	Units Container 40'	Units Container HC	Units Trayler 70m <sup>3</sup>	Units Truck 100m <sup>3</sup>
1X	x x		26			33

#### SHELL COLOR



Silver Grey

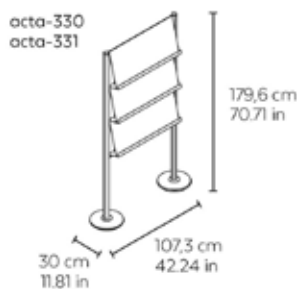

### ACTA-331 MERCHANDISING

A range of desktop and foot signs, to install as fixed or occasional items as required. Indoor two-sided magazine rack for three Din A4 per shelf. Frame made of extruded aluminum profiles supported on two cast steel bases with trim to provide structural stability. There are additional models available in the same series in various sizes, types of signage and merchandising formats. ACCESSORIES: set of wheels for two bases ref. Acta-250

#### MEASUREMENTS

W 107,3cm × L 30cm × H 179,6cm

W 42.25in × L 11.82in × H 70.7in

#### CHARACTERISTICS

Weight 0 Kg.

STD units	Packaging dim. (cm)	Units Container 20'	Units Container 40'	Units Container HC	Units Trayler 70m <sup>3</sup>	Units Truck 100m <sup>3</sup>
1X	x x		26			33

#### SHELL COLOR



Silver Grey

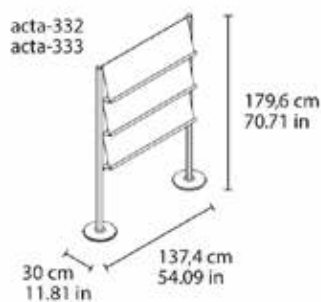

### ACTA-332 MERCHANDISING

A range of desktop and foot signs, to install as fixed or occasional items as required. Indoor single-sided magazine rack for four vertical DIN A4 per shelf. Frame made of extruded aluminum profiles supported on two cast steel bases with trim to provide structural stability. There are additional models available in the same series in various sizes, types of signage and merchandising formats. ACCESSORIES: set of wheels for two bases ref. Acta-250

#### MEASUREMENTS

W 137cm × L 30cm × H 179,6cm

W 53.94in × L 11.82in × H 70.71in

STD units	Packaging dim. (cm)	Units Container 20'	Units Container 40'	Units Container HC	Units Trayler 70m <sup>3</sup>	Units Truck 100m <sup>3</sup>
1X	x x		26			33

#### SHELL COLOR



Silver Grey

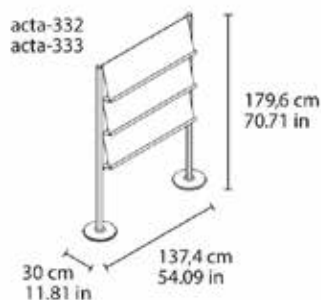

### ACTA-333 MERCHANDISING

A range of desktop and foot signs, to install as fixed or occasional items as required. Indoor two-sided magazine rack for four vertical DIN A4 per shelf. Frame made of extruded aluminum profiles supported on two cast steel bases with trim to provide structural stability. There are additional models available in the same series in various sizes, types of signage and merchandising formats. ACCESSORIES: set of wheels for two bases ref. Acta-250

#### MEASUREMENTS

W 137,4cm × L 30cm × H 179,6cm

W 54.1in × L 11.82in × H 70.71in

STD units	Packaging dim. (cm)	Units Container 20'	Units Container 40'	Units Container HC	Units Trayler 70m <sup>3</sup>	Units Truck 100m <sup>3</sup>
1X	x x		211			264

#### SHELL COLOR



Silver Grey

## ACTA-340 MERCHANDISING

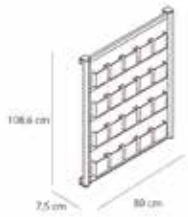

A range of desktop and foot signs, to install as fixed or occasional items as required.

Indoor wall-mounted leaflet holder for 210x100 cm leaflets. Frame made of extruded aluminum profiles with 20 methacrylate holders. Equipped with four rows of five holders each. Easy installation using screws and anchors. There are additional models available in the same series in various sizes, types of signage and merchandising formats.

### MEASUREMENTS

W 80cm × L 7,5cm × H 109,6cm

W 31.5in × L 2.96in × H 43.15in

### CHARACTERISTICS

**Weight** 13 Kg.

STD units	Packaging dim. (cm)	Units Container 20'	Units Container 40'	Units Container HC	Units Trayler 70m <sup>3</sup>	Units Truck 100m <sup>3</sup>
1X	x x		26			33

### SHELL COLOR



Silver Grey

## ACTA-350 MERCHANDISING

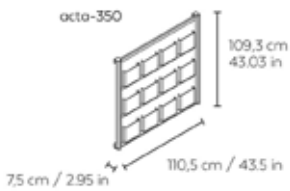

A range of desktop and foot signs, to install as fixed or occasional items as required.

Indoor wall-mounted leaflet holder for DIN A4 leaflets. Frame made of extruded aluminum profiles with 12 methacrylate holders. Equipped with three rows of four holders each. Easy installation using screws and anchors. There are additional models available in the same series in various sizes, types of signage and merchandising formats.

### MEASUREMENTS

W 110,5cm × L 7,5cm × H 109,3cm

W 43.5in × L 2.96in × H 43.04in

### CHARACTERISTICS

**Weight** 13 Kg.

STD units	Packaging dim. (cm)	Units Container 20'	Units Container 40'	Units Container HC	Units Trayler 70m <sup>3</sup>	Units Truck 100m <sup>3</sup>
1X	x x		26			33

### SHELL COLOR



Silver Grey



## ACTA-360 MERCHANDISING



A range of desktop and foot signs, to install as fixed or occasional items as required. Indoor wall-mounted leaflets holder for DIN A5 leaflets. Frame made of extruded aluminum profiles with 16 methacrylate holders. Equipped with three rows of four holders each. Easy installation using screws and anchors. There are additional models available in the same series in various sizes, types of signage and merchandising formats.

### MEASUREMENTS

W 80cm × L 7,5cm × H 108,6cm  
W 31.5in × L 2.96in × H 42.76in

### CHARACTERISTICS

**Weight** 13 Kg.

STD units	Packaging dim. (cm)	Units Container 20'	Units Container 40'	Units Container HC	Units Trayler 70m <sup>3</sup>	Units Truck 100m <sup>3</sup>
1X	x x		26			33

### SHELL COLOR



Silver Grey

acta-370

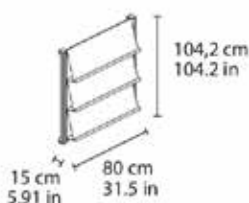

## ACTA-370 MERCHANDISING

A range of desktop and foot signs, to install as fixed or occasional items as required. Wall-mounted magazine display 3 Din A4. Frame made of extruded aluminum profiles with three steel magazines racks. Easy installation using screws and anchors. There are additional models available in the same series in various sizes, types of signage and merchandising formats.

### MEASUREMENTS

W 80cm × L 15cm × H 104,2cm  
W 31.5in × L 5.91in × H 41.03in

### CHARACTERISTICS

**Weight** 14 Kg.

STD units	Packaging dim. (cm)	Units Container 20'	Units Container 40'	Units Container HC	Units Trayler 70m <sup>3</sup>	Units Truck 100m <sup>3</sup>
1X	x x		2376			2970

### SHELL COLOR



Silver Grey

## ACTA-372 MERCHANDISING



A range of desktop and foot signs, to install as fixed or occasional items as required. Wall-mounted magazine display 4 Din A4. Frame made of extruded aluminum profiles with three steel magazines racks. Easy installation using screws and anchors. There are additional models available in the same series in various sizes, types of signage and merchandising formats.

### MEASUREMENTS

W 110cm × L 15cm × H 104,2cm  
W 43.31in × L 5.91in × H 41.03in

### CHARACTERISTICS

**Weight** 18 Kg.

STD units	Packaging dim. (cm)	Units Container 20'	Units Container 40'	Units Container HC	Units Trayler 70m <sup>3</sup>	Units Truck 100m <sup>3</sup>
1X	x x		26			33

### SHELL COLOR



Silver Grey

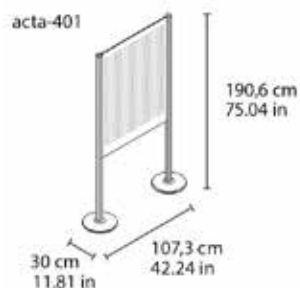

### ACTA-401 MERCHANDISING

A range of desktop and foot signs, to install as fixed or occasional items as required. Indoor metal billboard. Frame made of extruded aluminum profiles with perforated steel and foam sheeting that allows placement of literature using either magnets or thumbtacks. Frame supported on two cast steel bases, with cover trim, to provide structural stability. The useful billboard surface measures 100 x 70 cm. ACCESSORIES: brochure holder ref. Acta-200/1, bag 12 magnets ref. Acta-241 and set of wheels for two bases ref. Acta-250

#### MEASUREMENTS

W 107,3cm × L 30cm × H 190,6cm

W 42.25in × L 11.82in × H 75.04in

#### CHARACTERISTICS

**Weight** 33 Kg.

STD units	Packaging dim. (cm)	Units Container 20'	Units Container 40'	Units Container HC	Units Trayler 70m <sup>3</sup>	Units Truck 100m <sup>3</sup>
1X	x x		10692			13365

#### SHELL COLOR



Silver Grey



### ACTA-410 MERCHANDISING

A range of desktop and foot signs, to install as fixed or occasional items as required. Indoor wall-mounted metal billboard. Frame made of extruded aluminum profiles with perforated steel and foam sheeting that allows placement of literature using either magnets or thumbtacks. The useful billboard surface measures 100 x 70 cm. Easy installation using screws and anchors. There are additional models available in the same series in various sizes, types of signage and merchandising formats. ACCESSORIES: 12 magnets bag ref. Acta-241

#### MEASUREMENTS

W 80cm × L 6,2cm × H 99cm

W 31.5in × L 2.45in × H 38.98in

#### CHARACTERISTICS

**Weight** 11,5 Kg.

STD units	Packaging dim. (cm)	Units Container 20'	Units Container 40'	Units Container HC	Units Trayler 70m <sup>3</sup>	Units Truck 100m <sup>3</sup>
1X	x x		10560			13200

#### SHELL COLOR



Anthracite